5500 Series of Instruments

System User Guide



This document is provided to customers who have purchased SCIEX equipment to use in the operation of such SCIEX equipment. This document is copyright protected and any reproduction of this document or any part of this document is strictly prohibited, except as SCIEX may authorize in writing.

Software that may be described in this document is furnished under a license agreement. It is against the law to copy, modify, or distribute the software on any medium, except as specifically allowed in the license agreement. Furthermore, the license agreement may prohibit the software from being disassembled, reverse engineered, or decompiled for any purpose. Warranties are as stated therein.

Portions of this document may make reference to other manufacturers and/or their products, which may contain parts whose names are registered as trademarks and/or function as trademarks of their respective owners. Any such use is intended only to designate those manufacturers' products as supplied by SCIEX for incorporation into its equipment and does not imply any right and/or license to use or permit others to use such manufacturers' and/or their product names as trademarks.

SCIEX warranties are limited to those express warranties provided at the time of sale or license of its products and are the sole and exclusive representations, warranties, and obligations of SCIEX. SCIEX makes no other warranty of any kind whatsoever, expressed or implied, including without limitation, warranties of merchantability or fitness for a particular purpose, whether arising from a statute or otherwise in law or from a course of dealing or usage of trade, all of which are expressly disclaimed, and assumes no responsibility or contingent liability, including indirect or consequential damages, for any use by the purchaser or for any adverse circumstances arising therefrom.
(GEN-IDV-09-10816-D)

For Research Use Only. Not for use in Diagnostic Procedures.

Trademarks and/or registered trademarks mentioned herein, including associated logos, are the property of AB Sciex Pte. Ltd., or their respective owners, in the United States and/or certain other countries (see sciex.com/trademarks).

AB SCIEX™ is being used under license.

© 2021 DH Tech. Dev. Pte. Ltd.



AB Sciex Pte. Ltd.
Blk33, #04-06 Marsiling Industrial Estate Road 3
Woodlands Central Industrial Estate, Singapore 739256

Contents

1 Operational Precautions and Limitations	5
General Safety Information.....	5
Documentation Symbols and Conventions.....	5
Regulatory Compliance.....	6
Australia and New Zealand.....	6
Canada.....	6
Europe.....	7
United States.....	7
International.....	7
Electrical Precautions.....	8
Mains Supply.....	8
Protective Earth Conductor.....	9
Chemical Precautions.....	9
System Safe Fluids.....	10
Ventilation Precautions.....	11
Physical Precautions	12
Environmental Precautions.....	12
Electromagnetic Environment.....	13
Decommissioning and Disposal.....	14
Qualified Personnel.....	15
Laboratory Conditions.....	15
Safe Environmental Conditions.....	15
Performance Specifications.....	15
Equipment Use and Modification.....	16
2 Principles of Operation	17
System Overview.....	17
Hardware Overview.....	18
Theory of Operation—Hardware	21
3 Operating Instructions — Hardware	24
Start Up the System.....	24
Syringe Pump.....	25
Adjust the Integrated Syringe Pump Position.....	25
Diverter Valve.....	29
Plumb the Diverter Valve in Injector Mode.....	30
Plumb the Diverter Valve in Diverter Mode.....	31
Shut Down and Vent the System.....	32
Reset the Mass Spectrometer.....	33

Contents

4 Operating Instructions — User Workflows	34
5 Service and Maintenance Information.....	36
Recommended Maintenance Schedule.....	36
Clean the Surfaces.....	38
Clean the Front-End.....	39
Symptoms of Contamination.....	39
Required Materials.....	40
Cleaning Best Practices.....	41
Prepare the Mass Spectrometer.....	42
Clean the Curtain Plate.....	43
Clean the Front of the Orifice Plate.....	44
Put the Mass Spectrometer Back in Service.....	45
Empty the Source Exhaust Drain Bottle.....	45
Inspect the Roughing Pump Oil Level.....	47
Storage and Handling.....	47
6 Mass Spectrometer Troubleshooting.....	49
A Calibration Ions and Solutions.....	54
B Glossary of Symbols.....	56
C Glossary of Warnings.....	62
Contact Us.....	64
Customer Training.....	64
Online Learning Center.....	64
SCIEX Support.....	64
CyberSecurity.....	64
Documentation.....	64

Operational Precautions and Limitations

1

Note: Before operating the system, carefully read all of the sections of this guide.

This section contains general safety-related information and provides regulatory compliance information. It also describes potential hazards and associated warnings for the system and the precautions that should be taken to minimize the hazards.

In addition to this section, for information about the symbols and conventions used in the laboratory environment, on the system, and in this documentation, refer to the section: [Glossary of Symbols](#). For site requirements, including mains supply, source exhaust, ventilation, compressed air, nitrogen, and roughing pump requirements, refer to the document: *Site Planning Guide*.

General Safety Information

To prevent personal injury or system damage, read, understand, and obey all of the safety precautions and warnings in this document, the manufacturer chemical safety data sheet (SDS), and product label information. Labels are shown with internationally recognized symbols. Failure to heed these warnings could result in serious injury.

This safety information is intended to supplement federal, state, provincial, and local environmental health and safety (EHS) regulations. The information provided covers system-related safety information applicable to the operation of the system. It does not cover every safety procedure that should be practiced. Ultimately, the user and the organization are responsible for compliance with federal, state, provincial, and local EHS regulations and for maintaining a safe laboratory environment.

Refer to the appropriate laboratory reference material and standard operating procedures.

Documentation Symbols and Conventions

The following symbols and conventions are used throughout the guide.



DANGER! Danger signifies an action that leads to severe injury or death.

Operational Precautions and Limitations



WARNING! Warning signifies an action that could cause personal injury if precautions are not followed.

CAUTION: Caution signifies an operation that could cause damage to the system or corruption or loss of data if precautions are not followed.

Note: Note emphasizes significant information in a procedure or description.

Tip! Tip provides useful information that helps apply the techniques and procedures in the text for a specific need and provides shortcuts, but is not essential to the completion of a procedure.

Regulatory Compliance

This system complies with the regulations and standards listed in this section. For dated references, refer to the Declaration of Conformity included with the system and the individual system components. Applicable labels have been affixed to the system.

Australia and New Zealand

- **Electromagnetic Compatibility (EMC):** Radio Communications Act 1992 as implemented in these standards:
 - Electromagnetic Interference—AS/NZS CISPR 11/ EN 55011/ CISPR 11 (Class A). Refer to the section: [Electromagnetic Interference](#).
- **Safety:** AS/NZ 61010-1 and IEC 61010-2-061

Canada

- **Electromagnetic Interference (EMI):** CAN/CSA CISPR11. This ISM device complies with Canadian ICES-001. Refer to the section: [Electromagnetic Interference](#).
- **Safety:**
 - CAN/CSA C22.2 No. 61010-1
 - CAN/CSA C22.2 No 61010-2-061

Europe

- **Electromagnetic Compatibility (EMC):** Electromagnetic Compatibility Directive 2014/30/EU as implemented in these standards:
 - EN 61326-1
 - EN 55011 (Class A)Refer to the section: [Electromagnetic Compatibility](#).
- **Safety:** Low Voltage Directives 2014/35/EU as implemented in these standards:
 - EN 61010-1
 - EN 61010-2-061
- **Waste Electrical and Electronic Equipment (WEEE):** Waste Electrical and Electronic Equipment Directive 2012/96/EEC, as implemented in EN 40519. Refer to the section: [Waste Electrical and Electronic Equipment](#).
- **Packaging and Packaging Waste (PPW):** Packaging and Packaging Waste Directive 94/62/EC
- **RoHS Restriction of Hazardous Substances:** RoHS Directive 2011/65/EU

United States

- **Radio Emissions Interference Regulations:** 47 CFR 15, as implemented in FCC Part 15 (Class A)
- **Safety:** Occupational Safety and Health Regulations, 29 CFR 1910, as implemented in these standards:
 - UL 61010-1
 - IEC 61010-2-061

International

- **Electromagnetic Compatibility (EMC):**
 - IEC 61326-1
 - IEC CISPR 11 (Class A)
 - IEC 61000-3-2
 - IEC 61000-3-3Refer to the section: [Electromagnetic Compatibility](#).

- **Safety:**
 - IEC 61010-1
 - IEC 61010-2-061

Electrical Precautions



WARNING! Electrical Shock Hazard. Do not remove the covers. Removing the covers might cause injury or malfunctioning of the system. The covers need not be removed for routine maintenance, inspection, or adjustment. Contact a SCIEX Field Service Employee (FSE) for repairs that require the covers to be removed.

- Follow required electrical safe work practices.
- Use cable management practices to control electrical cables. This will decrease the chance of a tripping hazard.

For information about system electrical specifications, refer to the document: *Site Planning Guide*.

Mains Supply

Connect the system to a compatible mains supply as instructed in this guide.



WARNING! Electrical Shock Hazard. Use only qualified personnel for the installation of all of the electrical supplies and fixtures, and make sure that all of the installations adhere to local regulations and safety standards.



WARNING! Electrical Shock Hazard. Make sure that the system can be disconnected from the mains supply outlet in an emergency. Do not block the mains supply outlet.



WARNING! Electrical Shock Hazard. Use only the mains supply cables supplied with the system. Do not use mains supply cables that are not properly rated for the operation of this system.

An external line transformer is not needed for the mass spectrometer, optional bench, or roughing pump.

Protective Earth Conductor

The mains supply must include a correctly installed protective earth conductor. The protective earth conductor must be installed or examined by a qualified electrician before the system is connected.



WARNING! Electrical Shock Hazard. Do not intentionally interrupt the protective earth conductor. Any interruption of the protective earth conductor creates an electrical shock hazard.



WARNING! Electrical Shock Hazard. Make sure that a protective earth conductor (grounding cable) is connected between the sample loop and an appropriate grounding point at the ion source. This supplementary grounding reinforces the safety configuration specified by SCIEX.

Chemical Precautions



WARNING! Ionizing Radiation Hazard, Biohazard, or Toxic Chemical Hazard. Determine whether decontamination is required before cleaning or maintenance. If radioactive materials, biological agents, or toxic chemicals have been used with the system, then the customer must decontaminate the system before cleaning or maintenance.



WARNING! Environmental Hazard. Do not dispose of system components in municipal waste. Follow local regulations when disposing of components.



WARNING! Biohazard or Toxic Chemical Hazard. Connect the drain tubing to the mass spectrometer and the source exhaust drain bottle properly, to prevent leaks.

- Determine which chemicals have been used in the system prior to service and regular maintenance. For the health and safety precautions that must be followed for a chemical, refer to the document: *Safety Data Sheet*. For storage information, refer to the document: *Certificate of Analysis*. To find a SCIEX *Safety Data Sheet* or *Certificate of Analysis*, go to sciex.com/tech-regulatory.

Operational Precautions and Limitations

- Always wear assigned personal protective equipment, including powder-free gloves, safety glasses, and a laboratory coat.

Note: Nitrile or neoprene gloves are recommended.

- Work in a well-ventilated area or fume hood.
- Avoid ignition sources when working with flammable materials, such as isopropanol, methanol, and other flammable solvents.
- Take care in the use and disposal of any chemicals. There is potential risk of personal injury if proper procedures for handling and disposal of chemicals are not followed.
- Avoid skin contact with chemicals during cleaning, and wash hands after use.
- Make sure that all exhaust hoses are connected properly and that all connections are functioning as designed.
- Collect all spent liquids and dispose of them as hazardous waste.
- Comply with all of the local regulations for the storage, handling, and disposal of biohazardous, toxic, and radioactive materials.
- (Recommended) Use secondary containment trays beneath the roughing pump, the solvent bottles, and the waste container to capture potential chemical spills.

System Safe Fluids

The following fluids can safely be used with the system. For information about safe cleaning solutions, refer to the section: [Required Materials](#).

CAUTION: Potential System Damage. Do not use any other fluid until confirmation is received from SCIEX that it does not present a hazard. This is not an exhaustive list.

Note: Use only new, freshly prepared LC-MS-grade or better solvents for the LC mobile phases.

- **Organic Solvents**
 - LC-MS-grade acetonitrile; up to 100%
 - LC-MS-grade methanol; up to 100%
 - LC-MS-grade isopropanol; up to 100%
 - LC-MS-grade or higher water; up to 100%

- **Buffers**
 - Ammonium acetate; less than 100 mM
 - Ammonium formate; less than 100 mM
- **Acids and Bases**
 - Formic acid; less than 1%
 - Acetic acid; less than 1%
 - Trifluoroacetic acid (TFA); less than 1%
 - Heptafluorobutyric acid (HFBA); less than 1%
 - Ammonia/ammonium hydroxide; less than 1%

Ventilation Precautions

The venting of fumes and disposal of waste must comply with all of the federal, state, provincial, and local health and safety regulations. It is the responsibility of the customer to make sure that the air quality is maintained in compliance with local health and safety regulations.

The source exhaust system and roughing pump must be vented to a dedicated laboratory fume hood or an external exhaust system.



WARNING! Fire Hazard. Make sure that the source exhaust system is connected and functioning, to prevent flammable vapor from accumulating in the ion source.



WARNING! Ionizing Radiation Hazard, Biohazard, or Toxic Chemical Hazard. Take care to vent exhaust gases to a dedicated laboratory fume hood or exhaust system and make sure that the ventilation tubing is secured with clamps. Make sure that the laboratory has appropriate air exchange for the work performed.



WARNING! Ionizing Radiation Hazard, Biohazard, or Toxic Chemical Hazard. Do not operate the mass spectrometer if the source exhaust drain and roughing pump exhaust hoses are not properly connected to the laboratory ventilation system. Examine the exhaust tubing regularly to make sure that there are no leaks. The use of mass spectrometers without proper system ventilation might constitute a health hazard and might result in serious injury.

Operational Precautions and Limitations



WARNING! Ionizing Radiation Hazard, Biohazard, or Toxic Chemical Hazard. Do not use the ion source without knowledge of and training in the proper use, containment, and evacuation of toxic or injurious materials used with the ion source.



WARNING! Puncture Hazard, Ionizing Radiation Hazard, Biohazard, or Toxic Chemical Hazard. Discontinue use of the ion source if the ion source window is cracked or broken, and then contact a SCIEX Field Service Employee (FSE). Any toxic or injurious materials introduced in the equipment will be present in the source exhaust output. Exhaust from equipment should be vented from the room. Dispose of sharps following established laboratory safety procedures.

Physical Precautions



WARNING! Hot Surface Hazard. Let the Turbo V ion source cool for at least 30 minutes before starting any maintenance procedures. Some surfaces of the ion source and vacuum interface become hot during operation.



WARNING! Lifting Hazard. Use a mechanical lifting device to lift and move the mass spectrometer. If the mass spectrometer must be moved manually, then at least six people are required to move it safely. Follow established safe lifting procedures. We recommend the use of a professional moving service. For the weights of system components, refer to the document: *Site Planning Guide*.

Environmental Precautions

Use qualified personnel for the installation of electrical mains, heating, ventilation, and plumbing supplies and fixtures. Make sure that all of the installations comply with local bylaws and biohazard regulations. For information about the required environmental conditions for the system, refer to the document: *Site Planning Guide*.

Allow access space around the equipment when setting up the system.



DANGER! Explosion Hazard. Do not operate the system in an environment containing explosive gases. The system is not designed for operation in an explosive environment.



WARNING! Biohazard. For biohazardous material use, always comply with local regulations for hazard assessment, control, and handling. This system or any part is not intended to act as a biological containment.



WARNING! Environmental Hazard. Follow established procedures for disposal of biohazardous, toxic, radioactive, and electronic waste. The customer is responsible for disposal of hazardous substances, including chemicals, waste oils, and electrical components, in accordance with local laws and regulations.

CAUTION: Potential Mass Shift. Maintain a stable ambient temperature. If the temperature changes by more than 2 °C per hour, then the resolution and mass calibration might be affected.

Electromagnetic Environment

Electromagnetic Compatibility

Basic Electromagnetic Environment: Environment existing at locations characterized by being supplied directly at low voltage from the public mains network.

Performance Criteria A (Criteria A): Equipment shall operate as intended with no degradation of performance and no loss of function during or after test.

Performance Criteria B (Criteria B): Equipment may experience loss of function (one or more) during test but shall operate as intended with some degradation of performance and functions self-recoverable after test.

Performance Criteria C (Criteria C): Equipment may experience loss of function (one or more) during test but shall operate as intended with some degradation of performance and functions recoverable by operator after test.

The equipment is intended for use in a basic electromagnetic environment.

The expected performance loss under the electromagnetic immunity conditions is less than 60% change in total ion count (TIC).

Make sure that a compatible electromagnetic environment for the equipment can be maintained so that the device will perform as intended. If the power supply line is subject to high electrical noise, then install a surge protector.

Electromagnetic Interference

Group 1 Equipment: This equipment is classified as industrial, scientific, and medical (ISM) equipment that might use RF energy for internal operation.

Operational Precautions and Limitations

Class A Equipment: Equipment which is suitable for use in all establishments other than domestic and those directly connected to a low voltage power supply network which supplies buildings used for domestic purposes. [Derived from CISPR 11:2009, 5.3] Class A equipment shall meet Class A limits.

CAUTION: Potential Radio Interference. This equipment is not intended for use in residential environments and may not provide adequate protection to radio reception in such environments.

This equipment has been tested and found to comply with the limits for a Class A digital device, pursuant to Part 15 of the FCC (Federal Communications Commission) Compliance Rules.

These limits are designed to provide reasonable protection against harmful interference when the equipment is operated in a commercial environment. This equipment generates, uses, and can radiate radio frequency energy and, if not installed and used in accordance with the operator's manual, can cause harmful interference to radio communications.

Operation of this equipment in a residential area is likely to cause harmful interference in which case you will be required to correct the interference, at your own expense. Changes or modifications not expressly approved by the manufacturer could void your authority to operate the equipment.

Decommissioning and Disposal



WARNING! Environmental Hazard. Follow established procedures for disposal of biohazardous, toxic, radioactive, and electronic waste. The customer is responsible for disposal of hazardous substances, including chemicals, waste oils, and electrical components, in accordance with local laws and regulations.

Before decommissioning, decontaminate the entire system following local regulations.

When removing the system from service, separate and recycle different materials according to national and local environmental regulations. Refer to the section: [Storage and Handling](#).

Note: SCIEX will not accept any system returns without a completed Decontamination Form. Contact an FSE to obtain a copy of the form.

Do not dispose of system components or subassemblies, including computer parts, as unsorted municipal waste.

Waste Electrical and Electronic Equipment

Follow local municipal waste ordinances for proper disposal provisions to reduce the environmental impact of waste, electrical, and electronic equipment (WEEE). To safely dispose of this equipment, contact a local Customer Service office for complimentary equipment pick-up and recycling.

Qualified Personnel

Only qualified SCIEX personnel shall install, inspect, and service the equipment. After installing the system, the Field Service Employee (FSE) uses the *Customer Familiarization Checklist* to orient the customer on system operation, cleaning, and basic maintenance. SCIEX might not cover the damage to a system under warranty if it is serviced by personnel not authorized by SCIEX.

Only personnel qualified by the manufacturer shall maintain the equipment. A laboratory designate can be familiarized with the Qualified Maintenance Person (QMP) procedures during the installation. A QMP is a person who is suitably aware of the electrical and chemical risks associated with servicing laboratory equipment.

Laboratory Conditions

Safe Environmental Conditions

The system is designed to operate safely under these conditions:

- Indoors
- Altitude: Up to 2,000 m (6,560 feet) above sea level
- Ambient temperature: 5 °C (41 °F) to 40 °C (104 °F)
- Relative humidity: 20% to 80%, non-condensing
- Mains supply voltage fluctuations: ±10% of the nominal voltage
- Transient overvoltages: Up to the levels of Overvoltage Category II
- Temporary overvoltages on the mains supply
- Pollution Degree 2

Performance Specifications

The system is designed to meet specifications under these conditions:

- An ambient temperature of 15 °C to 30 °C (59 °F to 86 °F)
Over time, the temperature must remain within a range of 4 °C (7.2 °F), with the rate of the change in temperature not exceeding 2 °C (3.6 °F) per hour. Ambient temperature fluctuations exceeding the limits might result in mass shifts in spectra.
- Relative humidity from 20% to 80%, non-condensing

Equipment Use and Modification



WARNING! Personal Injury Hazard. Contact the SCIEX representative if product installation, adjustment, or relocation is required.



WARNING! Electrical Shock Hazard. Do not remove the covers. Removing the covers might cause injury or malfunctioning of the system. The covers need not be removed for routine maintenance, inspection, or adjustment. Contact a SCIEX Field Service Employee (FSE) for repairs that require the covers to be removed.



WARNING! Personal Injury Hazard. Use SCIEX-recommended parts only. Use of parts not recommended by SCIEX or use of parts for any purpose other than their intended purpose can put the user at risk of harm or negatively impact system performance.



WARNING! Lifting Hazard. Use a mechanical lifting device to lift and move the mass spectrometer. If the mass spectrometer must be moved manually, then at least six people are required to move it safely. Follow established safe lifting procedures. We recommend the use of a professional moving service. For the weights of system components, refer to the document: *Site Planning Guide*.



WARNING! Crushing Hazard. Wear protective footwear when moving heavy objects.

Use the system indoors in a laboratory that complies with the environmental conditions recommended in the document: mass spectrometer *Site Planning Guide*.

If the system is used in an environment or in a manner not prescribed by the manufacturer, then the performance and protection provided by the equipment might be impaired.

Unauthorized modification or operation of the system might cause personal injury and equipment damage, and might void the warranty. Erroneous data might be generated if the system is operated outside the recommended environmental conditions or with unauthorized modifications. Contact an FSE for information on servicing the system.

The system is designed for the qualitative and quantitative analysis of chemical species.

This section includes information about the mass spectrometer. For an overview of the ion source, refer to the document: *Turbo V Ion Source Operator Guide*.

System Overview

This system is intended for the qualitative and quantitative analysis of chemical species.

- A SCIEX Triple Quad 5500 or QTRAP 5500 mass spectrometer with a roughing pump and a source of compressed air and nitrogen
- A Turbo V ion source that uses either the TurbolonSpray probe or the atmospheric pressure chemical ionization (APCI) probe. Refer to the document: *Turbo V Ion Source Operator Guide*.
- A SCIEX-supplied computer and monitor with the control software for instrument optimization, acquisition method development, data acquisition, and processing. For computer specifications and requirements, refer to the software documentation.

Hardware Overview

Figure 2-1 Front View

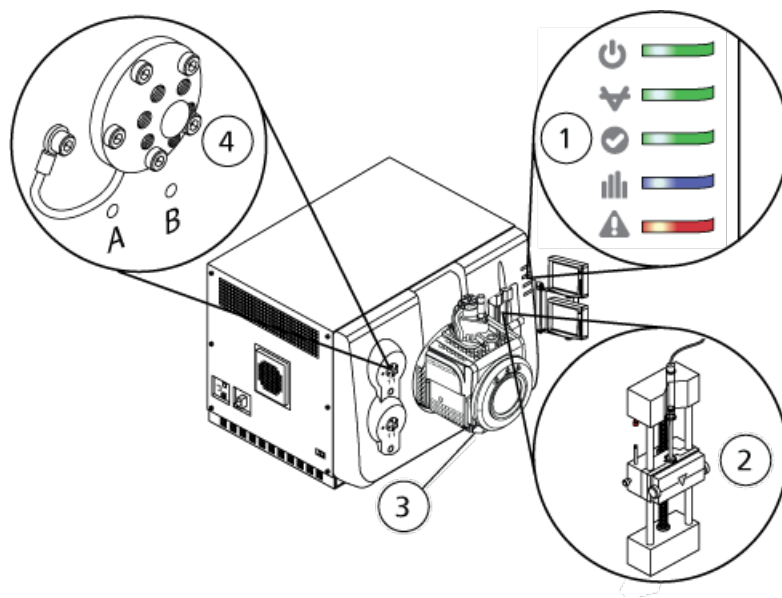





Item	Description	Refer
1	Panel symbols	Panel Symbols.
2	Syringe pump	Adjust the Integrated Syringe Pump Position.
3	Ion source	<i>Turbo V Ion Source Operator Guide</i> , available from the ion source documentation DVD, or from the SCIEX website, at sciex.com .
4	Diverter valve	Diverter Valve.

Panel Symbols

The following table describes the mass spectrometer status LEDs.

Table 2-1 Panel Symbols

LED	Color	Name	Description
	Green	Power	Illuminated when the system is powered up.
	Green	Vacuum	Illuminated when the operating vacuum level has been achieved. Flashing if the vacuum is not at the correct level, that is, during pump down and venting.
	Green	Ready	Illuminated when the system is in the Ready state. The system must be in the Ready state to operate.
	Blue	Scanning	Flashing when the system is acquiring data.
	Red	Fault	Illuminated when the system encounters a system fault.

After the system is turned on, all of the LEDs illuminate. The power LED remains illuminated. The other LEDs flash for two seconds and then turn off. The vacuum LED starts flashing. After the operating vacuum level is achieved, this LED remains illuminated.

Connections

The following figure shows the location of the mass spectrometer connections, including the locations of the **RESET** and **VENT** buttons and the mass spectrometer convenience switch.

Principles of Operation

Figure 2-2 Back and Side Views

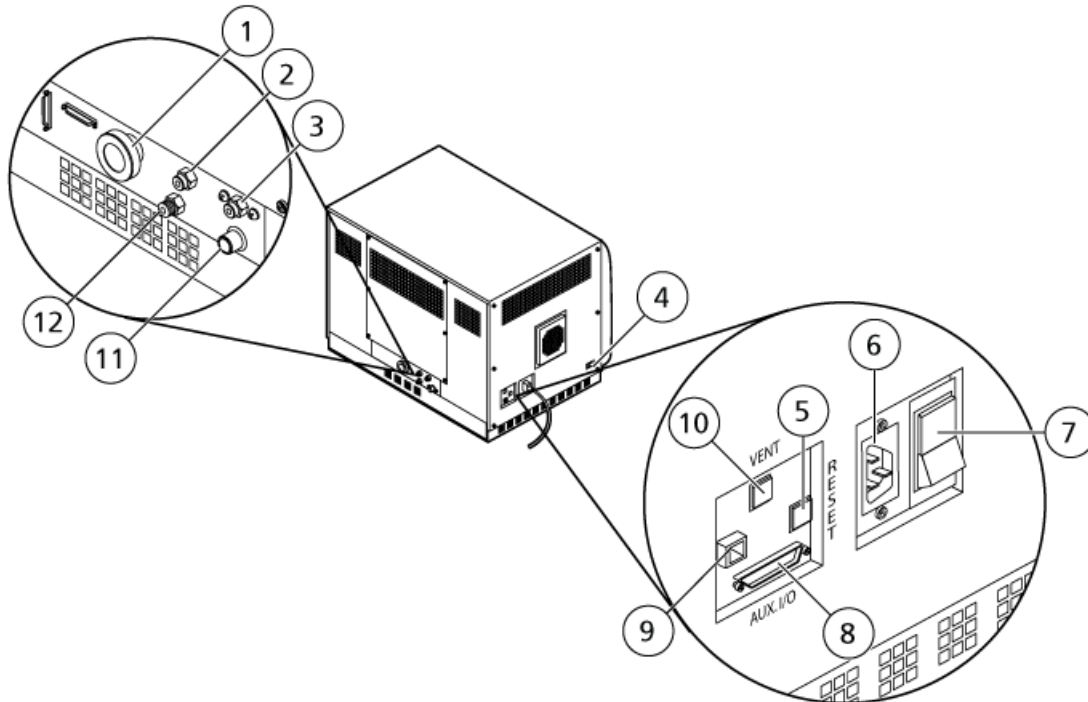

Item	Description	Primary Materials	For more information...
1	Roughing pump vacuum connection	Aluminum (hose fitting), zinc-plated steel (hose clamp)	Contact an FSE.
2	Air supply (Gas 1/Gas 2)	Plastic	Refer to the document: <i>Site Planning Guide</i> . Gas tubing from the Gas 1/Gas 2 supply connects to this port.
3	Source exhaust supply	Plastic	Refer to the document: <i>Site Planning Guide</i> . Gas tubing from the source exhaust gas supply connects to this port.
4	Source communication connection	Aluminum	Contact an FSE.
5	RESET button	Plastic	Refer to the section: Reset the Mass Spectrometer .
6	Mains supply connection	Aluminum/plastic	Refer to the section: Start Up the System or Shut Down and Vent the System .

Item	Description	Primary Materials	For more information...
7	Mass spectrometer convenience switch (Up = On; Down = Off)	Plastic	Refer to the section: Start Up the System or Shut Down and Vent the System .
8	Aux I/O connection	Sheet metal (zinc-plated)	Refer to the document: <i>Devices Setup Guide</i> or <i>Peripheral Devices Setup Guide</i> .
9	Ethernet connection (connects the mass spectrometer and the computer)	Sheet metal (zinc-plated)	Contact an FSE.
10	VENT button	Plastic	Refer to the section: Start Up the System or Shut Down and Vent the System .
11	Source exhaust waste (to source exhaust drain bottle)	Stainless steel	Refer to the document: <i>Site Planning Guide</i> .
12	Nitrogen gas supply (gas for the Curtain Gas™ interface, CAD gas)	Stainless steel	Refer to the document: <i>Site Planning Guide</i> . Gas tubing from the nitrogen gas supply connects to this port.

Theory of Operation—Hardware

Mass spectrometry measures the mass-to-charge ratio of ions to identify unknown compounds, to quantify known compounds, and to provide information about the structural and chemical properties of molecules.

The mass spectrometer has a series of quadrupole filters that transmit ions according to their mass-to-charge ratio (m/z). The first quadrupole in this series is the QJet ion guide, located between the orifice plate and the Q0 region. The QJet ion guide does not filter ions, but focuses them before they enter the Q0 region. The QJet ion guide helps to focus ions into the Q0 region. In the Q0 region, the ions are again focused before they enter the Q1 quadrupole.

Figure 2-3 Ion Path

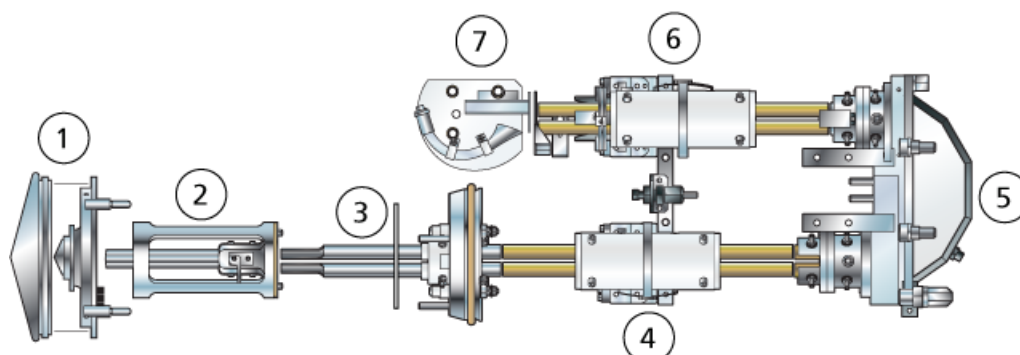

Item	Description
1	Curtain plate and orifice plate
2	QJet ion guide
3	Q0 region
4	Q1 quadrupole
5	Q2 collision cell
6	Q3 quadrupole
7	Detector

The Q1 quadrupole is a filtering quadrupole that sorts the ions before they enter the Q2 collision cell. In the Q2 collision cell the internal energy of an ion is increased through collisions with gas molecules until the molecular bonds break, creating product ions. This technique allows users to design experiments that measure the m/z of product ions to determine the composition of the parent ions.

After passing through the Q2 collision cell, the ions enter the Q3 quadrupole for additional filtering. Then they enter the detector. In the detector, the ions create a current that is converted into a voltage pulse. The voltage pulses leaving the detector are directly proportional to the quantity of ions entering the detector. The system monitors these voltage pulses and then converts the information into a signal. The signal represents the ion intensity for a particular m/z value and the system shows this information as a mass spectrum.

The linear ion trap (LIT) functionality provides a number of Enhanced modes of operation. A common factor of the Enhanced modes is that ions are trapped in the Q3 quadrupole region and then scanned out to produce full spectrum data. Many spectra are rapidly collected in a short period of time and are significantly more intense than spectra collected in a comparable standard quadrupole mode of operation.

During the collection phase, ions pass through the Q2 collision cell where the CAD gas focuses the ions into the Q3 region. The Q3 quadrupole is operated with only the main RF voltage applied. Ions are prevented from passing through the Q3 quadrupole and are reflected back by an exit lens to which a DC barrier voltage is applied. After the fill time elapses, a time defined by the user, or determined by the Dynamic Fill Time feature, a DC barrier voltage is applied to the Q3 entrance lens (IQ3). This voltage confines the collected ions in the Q3 region and stops additional ions from entering. The entrance and exit lens DC voltage barriers and the RF voltage applied to the quadrupole rods confine the ions within the Q3 region.

During the scan out phase, the voltage on the exit lens and the auxiliary RF voltage are ramped simultaneously with the main RF voltage for increased resolution and sensitivity as compared to quadrupole scan types. An auxiliary AC frequency is applied to the Q3 quadrupole. The main RF voltage amplitude is ramped from low to high values, which sequentially brings masses into resonance with the auxiliary AC frequency. When ions are brought into resonance with the AC frequency, they acquire enough axial velocity to overcome the exit lens barrier and are axially ejected towards the mass spectrometer ion detector. Full spectra data can be acquired from the ions collected in the Q3 region by rapidly scanning the main RF voltage.

Operating Instructions — Hardware

3



WARNING! Personal Injury Hazard. Follow the instructions in the documentation when using the system. The protection provided by the equipment might be impaired if the equipment is used in a manner not specified by SCIEX.

Start Up the System



WARNING! Electrical Shock Hazard. Make sure that the system can be disconnected from the mains supply outlet in an emergency. Do not block the mains supply outlet.

Note: Before operating the instrument, read the safety information in the section: [Operational Precautions and Limitations](#).

Prerequisites

- The site requirements specified in the *Site Planning Guide* are met. The *Site Planning Guide* includes information on the mains supply and connections, compressed air, nitrogen, roughing pump, ventilation, exhaust, and site clearance requirements. Contact SCIEX for a copy of the *Site Planning Guide*, if required. For contact information, go to sciex.com/contact-us.
- The source exhaust gas, compressed air, and nitrogen gases are connected to the mass spectrometer.
- The 4 L source exhaust drain bottle is connected to the exhaust waste connection on the back of the mass spectrometer and to the laboratory ventilation system.
- The source exhaust hoses are securely clamped at the mass spectrometer, source exhaust drain bottle, and ventilation connections.
- The mass spectrometer convenience switch is turned off and the mains supply cable is connected to the mass spectrometer.
- The mass spectrometer and roughing pump mains supply cables are connected to the 200 VAC to 240 VAC mains supply.
- The Ethernet cable is connected to both the mass spectrometer and the computer.

1. Turn on the mass spectrometer convenience switch. Refer to the figure: [Figure 2-2](#).
2. Turn on the computer.
3. Open the control software.

Syringe Pump

Adjust the Integrated Syringe Pump Position



WARNING! Puncture Hazard. Take care when handling the syringe. The tip of the syringe is extremely sharp.



WARNING! Puncture Hazard. Make sure that the syringe is seated properly in the syringe pump and that the automatic syringe pump stop is adjusted properly to avoid damaging or breaking the glass syringe. If the syringe breaks, follow established safety procedures for sharps disposal.

For the location of the syringe pump on the mass spectrometer, refer to the figure: [Figure 2-1](#).

1. Open the syringe cover.
2. Press the Release button on the right side of the syringe pump to lower the base and then insert the syringe.

Figure 3-1 Lowering the Syringe

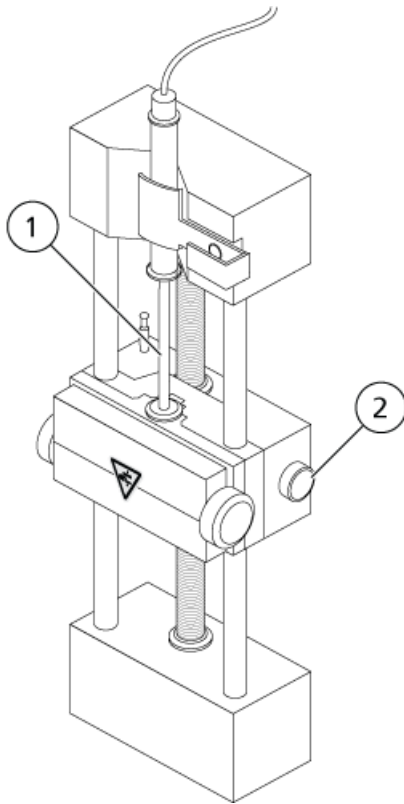

Item	Description
1	Syringe plunger
2	Release button. Press to raise or lower the base.

3. Make sure that the end of the syringe is flush with the base and that the shaft of the syringe rests in the cutout.
4. Adjust the post so that it triggers the automatic syringe stop before the syringe plunger hits the bottom of the glass syringe.

Figure 3-2 Automatic Syringe Stop

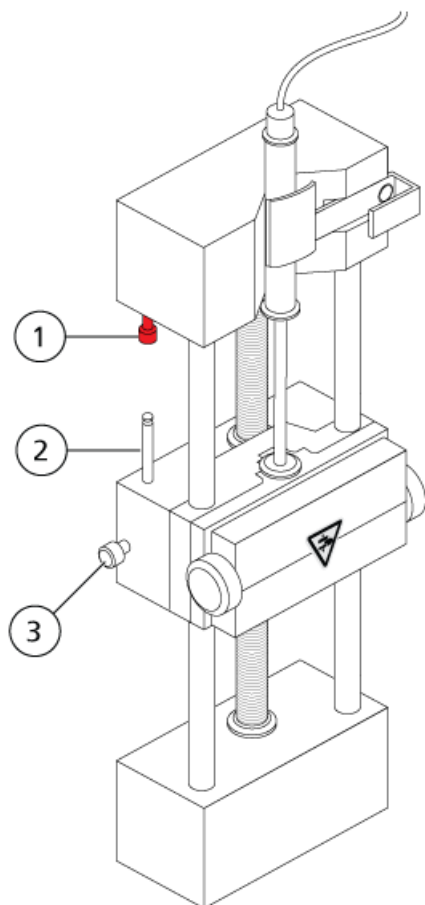

Item	Description
1	Automatic syringe stop. After the post hits the automatic syringe stop, the syringe pump stops.
2	Post. Adjust the height to prevent the syringe plunger from hitting the syringe during sample infusion.
3	Post lock screw. Tighten the screw after the height of the post is adjusted.

5. Turn the syringe pump screws to secure the syringe.

Figure 3-3 Syringe Pump Screws

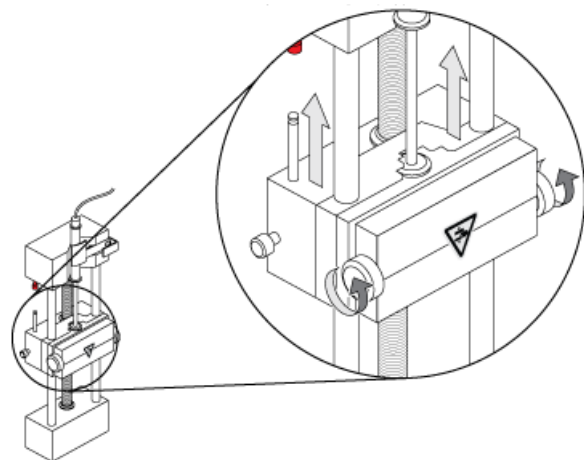

6. Make sure that the mass spectrometer and integrated syringe pump are activated in the software.

Note: For subsequent manual use, after the mass spectrometer is in Ready state, start the flow by pressing the button on the mass spectrometer that is to the right of the syringe. The LED beside the button flashes when the syringe pump is in use. The syringe pump flow can also be controlled automatically by the control software.

Figure 3-4 Syringe Pump LED

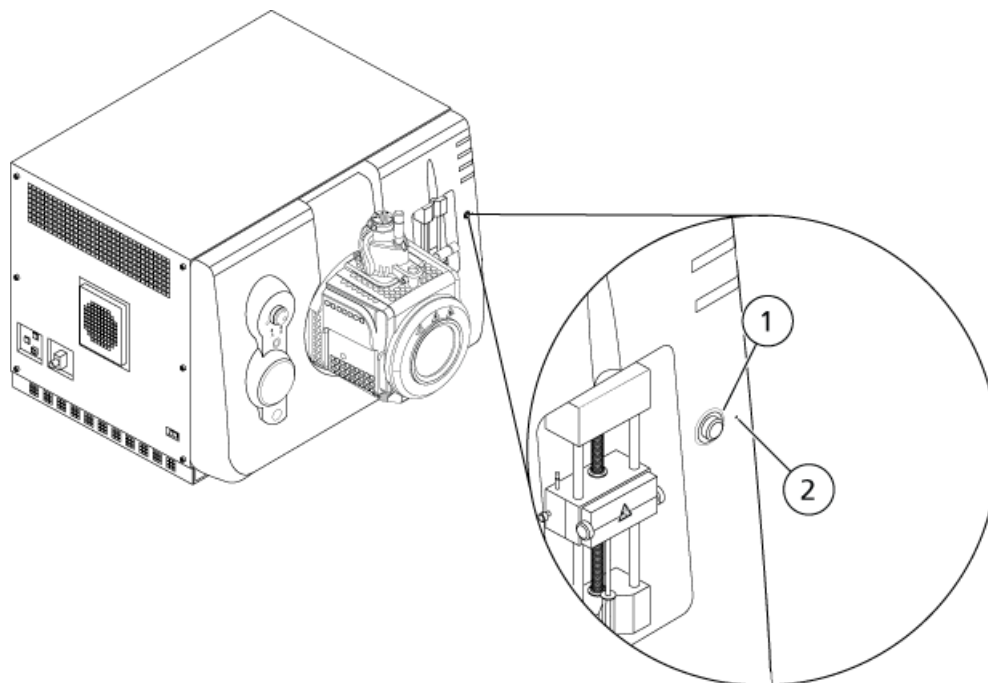

Item	Description
1	Syringe pump on and off button
2	Syringe pump status LED

- Use the control software to start or stop the syringe pump.

Diverter Valve

The diverter valve is a two-position, six-port valve. It can be plumbed in Injector mode or Diverter mode. In Injector mode, it can be configured with a sample loop for sample injection. In Diverter mode, it can be configured to divert sample to waste at the beginning of each LC run.

CAUTION: Potential Wrong Result. Do not press the diverter valve button during a run. Doing so might result in incorrect data.

Plumb the Diverter Valve in Injector Mode

When the valve is in Position A, the sample flows through the external loop. When the valve switches to Position B, the sample is injected.

- Plumb the valve for Injector mode.

Figure 3-5 Diverter Valve—Injector Mode Position A

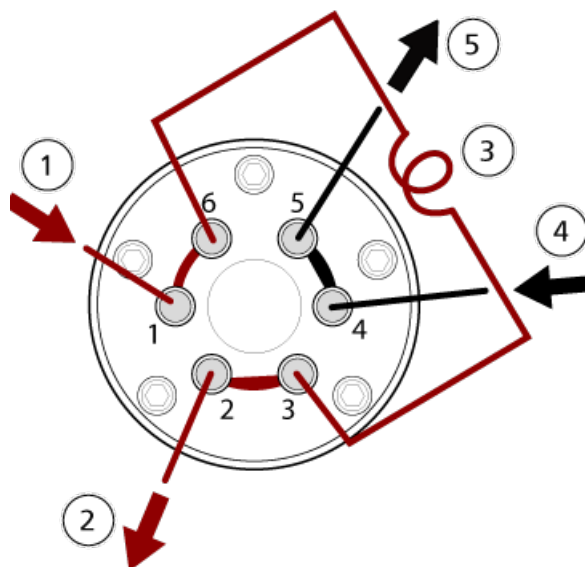
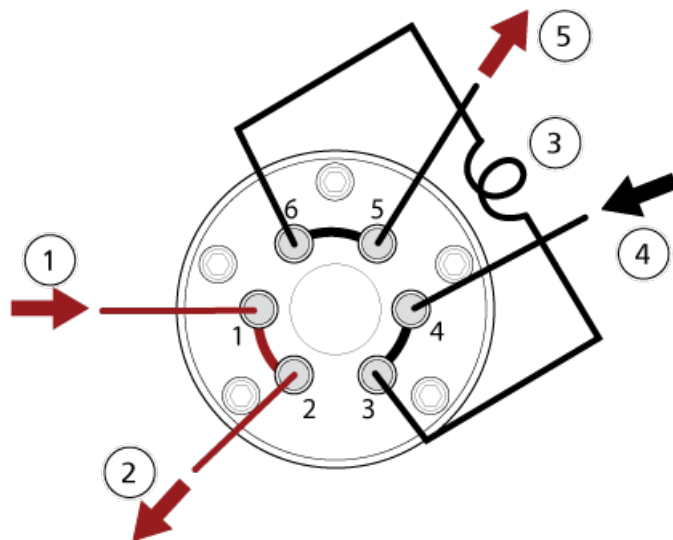

Figure 3-6 Diverter Valve—Injector Mode Position B



Item	Description
1	Sample in
2	Waste out
3	Sample loop (ports 3 and 6)
4	Mobile phase in
5	To column, or to the mass spectrometer, if a column is not installed

Plumb the Diverter Valve in Diverter Mode

When the valve is in Position A, the sample flow goes to the mass spectrometer. When the valve switches to Position B, the flow goes to waste.

- Plumb the valve for Diverter mode.

Figure 3-7 Diverter Valve—Diverter Mode Position A

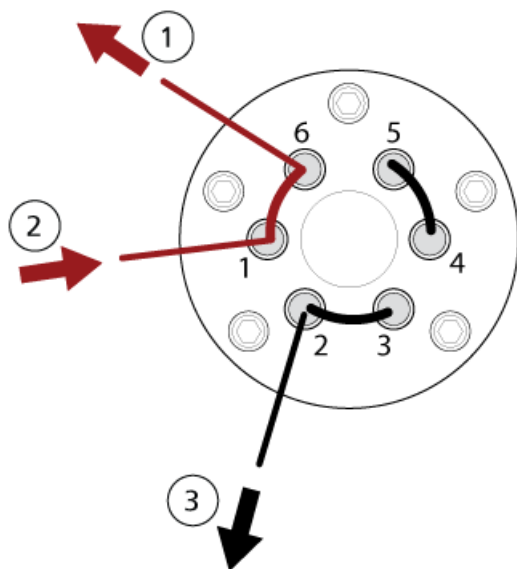
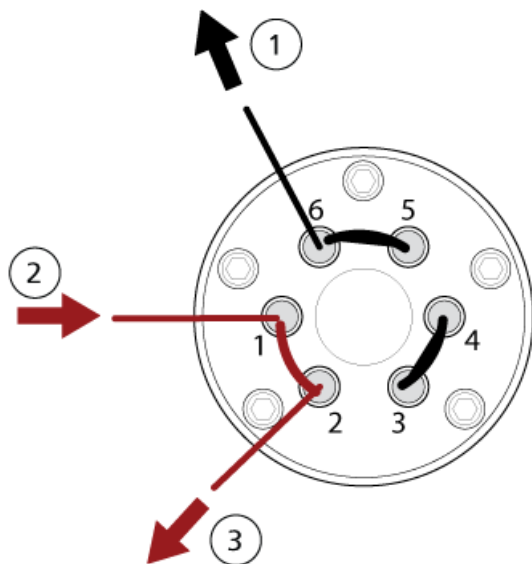

Figure 3-8 Diverter Valve—Diverter Mode Position B



Item	Description
1	To mass spectrometer
2	From column
3	Waste out

Shut Down and Vent the System

Some procedures require that the system be shut down. Others require that it also be vented. Follow these steps to shut down and, if required, vent the system.

CAUTION: Potential System Damage. Do not turn off the roughing pumps until after the turbo pumps have spun down.

Note: If the input gas supply must be disconnected, then relieve the pressure in the gas lines before disconnecting it.

Tip! If the mass spectrometer will not be used for an extended period, then leave it in Standby state with the ion source in place. If the mass spectrometer must be shut down, then follow these instructions.

1. Complete or stop any ongoing scans.

CAUTION: Potential System Damage. Turn off the sample flow before shutting down the system.

2. Turn off the sample flow to the system.
3. In the control software, deactivate the mass spectrometer if it is active. Refer to the document: *Software User Guide*.
4. Close the software.
5. (If required) Follow these steps to vent the system:

Note: Vent the system before performing a full cleaning of the vacuum interface, before cleaning the Q0 region, and before replacing the roughing pump oil. For more information, contact the Qualified Maintenance Person (QMP) or FSE.

- a. Press and hold the **Vent** button for three seconds. Refer to the figure: [Figure 2-2](#).
The Vacuum LED begins flashing more quickly than during pump down. The turbo pump spins down gradually.
 - b. Allow the system to vent for 15 minutes.
6. Turn off the mass spectrometer convenience switch.
 7. Disconnect the mass spectrometer mains supply cable from the mains supply outlet.
 8. (If venting the system) Disconnect the roughing pump mains supply cable from the mains supply outlet.

Reset the Mass Spectrometer

1. Stop any ongoing scans and then turn off sample flow to the mass spectrometer.
2. In the control software, deactivate the mass spectrometer. Refer to the document: *Software User Guide*.
3. Close the control software.
4. Press and hold the **Reset** button for five seconds.

A click is heard when the relay activates. After approximately 3 minutes, the mass spectrometer reaches operating pressure.

Operating Instructions — User Workflows

4

After the system is installed and configured, it is ready for use. The following table shows the workflows available. For each task, it lists a reference that contains more information.

Task	Reference
Analyst	
Monitor the system status	<i>Software User Guide</i> or Help System.
Create and submit batches	<i>Software User Guide</i> or Help System.
View and manage samples in the queue	<i>Software User Guide</i> or Help System.
Explore data	<i>Software User Guide</i> or Help System.
Method Developer	
Configure the system	<ul style="list-style-type: none"> • Configure the mass spectrometer: <i>Software User Guide</i> or Help System. • Create projects and data folders: <i>Software User Guide</i> or Help System • Configure the LC devices: <i>Software User Guide</i> or Help System
Tune the mass spectrometer	<i>Software User Guide</i> or Help System.
Create MS methods	<i>Software User Guide</i> or Help System.
Create LC methods	<i>Software User Guide</i> or Help System.
Develop processing methods	<i>Software User Guide</i> or Help System.
Administrator	
Set the Windows file permissions	<i>Laboratory Director Guide</i> .
Configure the LIMS	<i>Software User Guide</i> or Help System.
Add users to the software and assign roles	<i>Laboratory Director Guide</i> or Help System.
Archive logs	<i>Software User Guide</i> or Help System.
Reviewer	
Review processed results	<i>Software User Guide</i> or Help System.

Task	Reference
Explore data	<i>Software User Guide</i> or Help System.
Review logs	<i>Software User Guide</i> or Help System.

Service and Maintenance Information

5

Regularly clean and maintain the system for optimal performance.



WARNING! Electrical Shock Hazard. Do not remove the covers. Removing the covers might cause injury or malfunctioning of the system. The covers need not be removed for routine maintenance, inspection, or adjustment. Contact a SCIEX Field Service Employee (FSE) for repairs that require the covers to be removed.



WARNING! Ionizing Radiation Hazard, Biohazard, or Toxic Chemical Hazard. Determine whether decontamination is required before cleaning or maintenance. If radioactive materials, biological agents, or toxic chemicals have been used with the system, then the customer must decontaminate the system before cleaning or maintenance.

Recommended Maintenance Schedule

The following tables provide a recommended schedule for cleaning and maintaining the system.

Tip! Perform maintenance tasks regularly to make sure that the system is performing optimally.

- Perform periodic gas leakage tests and general maintenance inspections to be sure of safe operation of the system.
- Clean the system regularly to keep it in good working condition.
- During system maintenance, carefully inspect parts of the external gas supply system, including tubing connected to the equipment, to confirm that the condition is satisfactory. Replace any cracked, pinched, or collapsed tubing.

For information on maintaining the ion source, refer to the document: *Turbo V Ion Source Operator Guide*.

To determine how often to clean or perform maintenance on the mass spectrometer and ion source, consider the following factors. These factors can cause changes in mass spectrometer performance, indicating that maintenance is required.

- Compounds tested

- Cleanliness of the samples and the sample preparation methods
- Amount of time that the probe is exposed to the sample
- Overall system run time

For information about tuning frequency, refer to the section: [Calibration Ions and Solutions on page 54](#).

To order consumable parts and for basic service and maintenance requirements, contact a QMP or refer to the document: *Parts and Equipment Guide*. Contact a SCIEX FSE for all other service and maintenance requirements.

Table 5-1 Mass Spectrometer Maintenance Tasks

Component	Frequency	Task	For More Information
System	Daily	Inspect for leaks	Refer to the section: Chemical Precautions .
Curtain plate	Daily	Clean	Refer to the section: Clean the Curtain Plate .
Roughing pump oil	Weekly	Inspect the level	Refer to the section: Inspect the Roughing Pump Oil Level . Contact the local QMP or FSE to add oil, if required.
Roughing pump oil	Every 12 months, or as needed	Replace	Contact the local QMP or FSE.
Roughing pump oil	As needed	Refill	Contact the local QMP or FSE.
Orifice plate (front)	As needed	Clean	Refer to the section: Clean the Front of the Orifice Plate .
Orifice plate (front and back)	As needed	Clean	Contact the local QMP or FSE.
Mass spectrometer air filter	As needed	Replace	Contact the local QMP or FSE.
QJet ion guide and IQ0 lens	As needed	Clean	Contact the local QMP or FSE.
Q0 rod set and IQ1 lens	As needed	Clean	Contact the local QMP or FSE.
Instrument surfaces	As needed	Clean	Refer to the section: Clean the Surfaces .

Service and Maintenance Information

Table 5-1 Mass Spectrometer Maintenance Tasks (continued)

Component	Frequency	Task	For More Information
Source exhaust drain bottle	As needed	Empty	Refer to the section: Empty the Source Exhaust Drain Bottle .
Interface heater	As needed	Replace	Contact the local QMP or FSE.

Table 5-2 Ion Source Maintenance Tasks

Component	Frequency	Task	For More Information
TurbolonSpray and APCI probes	As needed	Inspect and replace	Refer to the document: <i>Turbo V Ion Source Operator Guide</i> .
Electrodes for the TurbolonSpray and APCI probes	As needed	Inspect and replace	Refer to the document: <i>Turbo V Ion Source Operator Guide</i> .
Corona discharge needle	As needed	Replace	Refer to the document: <i>Turbo V Ion Source Operator Guide</i> .
Turbo heater	As needed	Replace	Contact the local QMP or FSE.
Sample tubing	As needed	Replace	Refer to the document: <i>Turbo V Ion Source Operator Guide</i> .

For “As needed” tasks, follow these guidelines:

- Clean the mass spectrometer surfaces after a spill or when they become dirty.
- Empty the source exhaust drain bottle before it becomes full.
- Clean the orifice plate, QJet ion guide, and Q0 region if system sensitivity degrades.

Tip! Clean the Q0 region regularly to minimize the impact of charging, a significant loss of sensitivity of the ions of interest over a short period of time, on the quadrupoles and lenses. Contact a QMP or FSE.

- Refill the roughing pump oil when it falls below the minimum oil level.
- Periodically inspect all exhaust connections to make sure that the integrity is maintained, and that any exhaust is removed from the customer lab.

Clean the Surfaces

Clean the external surfaces of the mass spectrometer after a spill or when they become dirty.

CAUTION: Potential System Damage. Use only the recommended cleaning methods and materials to avoid damaging the equipment.

1. Wipe the external surfaces with a soft cloth dampened with warm, soapy water.
2. Wipe the external surfaces with a soft cloth dampened with water to remove any soap residue.

Clean the Front-End

The following warning applies to all of the procedures in this section:



WARNING! Hot Surface Hazard. Let the Turbo V ion source cool for at least 30 minutes before starting any maintenance procedures. Some surfaces of the ion source and vacuum interface become hot during operation.

Clean the mass spectrometer front-end using the routine cleaning method, to:

- Minimize unscheduled system downtime.
- Maintain optimum sensitivity.
- Avoid more extensive cleaning that requires a service visit.

When contamination occurs, perform an initial routine cleaning. Clean up to and including the front of the orifice plate. If routine cleaning does not resolve issues with sensitivity, then a full cleaning might be necessary. Contact the local QMP or FSE.

This section provides instructions for performing routine cleaning without breaking vacuum.

Note: Follow all of the applicable local regulations. For health and safety guidelines, refer to the section: [Chemical Precautions](#).

Symptoms of Contamination

The system might be contaminated if any one of the following is observed:

- Significant loss in sensitivity
- Increased background noise
- Additional peaks that are not part of the sample in full scan or survey scan methods

If any of these issues are observed, then clean the mass spectrometer front-end.

Service and Maintenance Information

Required Materials

Note: U.S. customers can call 877-740-2129 for ordering information and inquiries. International customers can visit sciex.com/contact-us.

- Powder-free gloves, nitrile or neoprene recommended
- Safety glasses
- Laboratory coat
- Fresh LC-MS-grade water. Old water can contain contaminants that can further contaminate the mass spectrometer.
- LC-MS-grade methanol, isopropanol (2-propanol), or acetonitrile
- Cleaning solution. Use one of:
 - 100% methanol
 - 100% isopropanol
 - 1:1 acetonitrile:water solution, freshly prepared
 - 1:1 acetonitrile:water with 0.1% acetic acid solution, freshly prepared
- Clean 1 L or 500 mL glass beaker to prepare cleaning solutions
- 1 L beaker to catch used solvent
- Organic waste container
- Lint-free wipes. Refer to the section: [Tools and Supplies Available from the Manufacturer](#).
- (Optional) Polyester (poly) swabs

Tools and Supplies Available from the Manufacturer

Description	Part Number
Small poly swab, thermally bonded. Also available in the Cleaning kit.	1017396
Lint-free wipe (11 cm x 21 cm, 4.3 inches x 8.3 inches). Also available in the Cleaning kit.	018027
Cleaning kit. Contains the small poly swab, lint-free wipes, Q0 cleaning tool, straight QJet ion guide cleaning brush, and Alconox.	5020761

Cleaning Best Practices



WARNING! Hot Surface Hazard. Let the Turbo V ion source cool for at least 30 minutes before starting any maintenance procedures. Some surfaces of the ion source and vacuum interface become hot during operation.



WARNING! Toxic Chemical Hazard. Refer to the chemical product *Safety Data Sheets* and follow all of the recommended safety procedures when handling, storing, and disposing of chemicals.



WARNING! Ionizing Radiation Hazard, Biohazard, or Toxic Chemical Hazard. Determine whether decontamination is required before cleaning or maintenance. If radioactive materials, biological agents, or toxic chemicals have been used with the system, then the customer must decontaminate the system before cleaning or maintenance.



WARNING! Environmental Hazard. Do not dispose of system components in municipal waste. Follow local regulations when disposing of components.

- Allow the ion source to cool before removing it.
- Always wear clean, powder-free gloves, nitrile or neoprene recommended, for the cleaning procedures.
- After cleaning the mass spectrometer components, and before reassembling them, put on a new, clean pair of gloves.
- Do not use cleaning supplies other than those specified in this procedure.
- If possible, prepare cleaning solutions just before cleaning.
- Prepare and store all of the organic solutions and organic-containing solutions in very clean glassware only. Never use plastic bottles. Contaminants can leach from these bottles and further contaminate the mass spectrometer.
- To avoid contaminating the cleaning solution, pour the solution on the wipe or swab.

Service and Maintenance Information

- Allow only the center area of the wipe to contact the mass spectrometer surface. Cut edges can leave fibers behind.

Tip! Wrap the wipe around a thermally-bonded poly swab.

Figure 5-1 Example: Folding the Wipe



- To avoid cross-contamination, discard the wipe or swab after it has touched the surface once.
- If required, perform multiple cleanings, using multiple wipes for larger parts of the vacuum interface, such as the curtain plate.
- Only dampen the wipe or swab slightly when applying water or cleaning solution. Water, more often than organic solvents, might cause the wipe to deteriorate, leaving residue on the mass spectrometer.
- Do not rub the wipe across the aperture. Wipe around the aperture to prevent fibers from the wipes from entering the mass spectrometer.
- Do not insert the brush in the aperture on the curtain plate or orifice plate.

Prepare the Mass Spectrometer



WARNING! Hot Surface Hazard. Let the Turbo V ion source cool for at least 30 minutes before starting any maintenance procedures. Some surfaces of the ion source and vacuum interface become hot during operation.

CAUTION: Potential System Damage. Do not drop anything in the source drain when the ion source is removed.

Figure 5-2 Source Drain on the Vacuum Interface

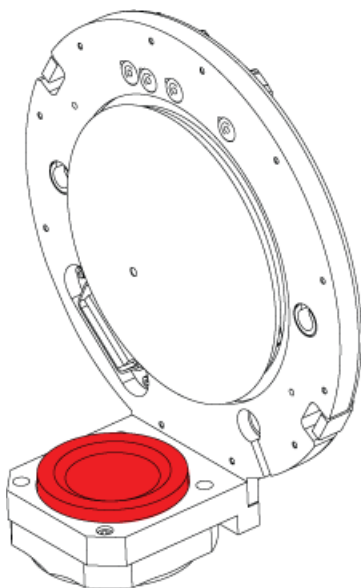

1. Deactivate the devices. Refer to the document: *Software User Guide*.
2. Remove the ion source. Refer to the document: *Operator Guide* for the ion source.
When the ion source is not in use, store it to protect it from damage and to maintain operating integrity.

Clean the Curtain Plate

CAUTION: Potential System Damage. Do not rest the curtain plate or orifice plate on the aperture tip. Make sure that the conical side of the curtain plate faces up.

CAUTION: Potential System Damage. To avoid damaging the aperture, do not insert a wire or metal brush in the aperture on the curtain plate, orifice plate, or interface heater.

1. Pull the curtain plate off of the vacuum interface and then put it, conical side up, on a clean, stable surface.

Figure 5-3 Curtain Plate Removal

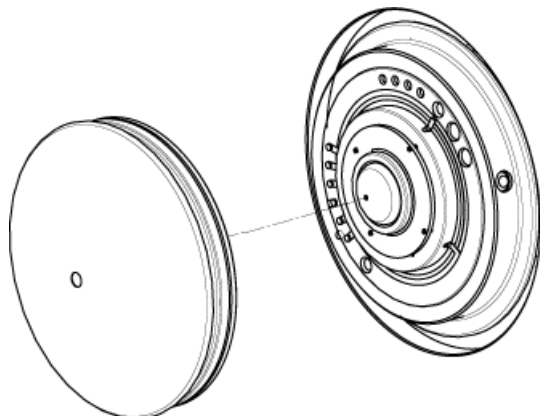

The curtain plate is held in place by three retaining ball catches mounted on the orifice plate.

Tip! If the curtain plate does not immediately separate from the orifice plate, then turn the curtain plate slightly, less than 90 degrees, to release the ball spring latches.

2. Dampen a lint-free wipe with LC-MS-grade water and then clean both sides of the curtain plate.

Note: Use multiple wipes, as required.

3. Repeat step 2 using the cleaning solution.
4. Using a dampened wipe or small poly swab, clean the aperture.
5. Wait until the curtain plate is dry.
6. Inspect the curtain plate for solvent stains or lint, removing any residue with a clean, slightly damp, lint-free wipe.

Note: Persistent spotting or filming is an indicator of contaminated solvent.

Clean the Front of the Orifice Plate

CAUTION: Potential System Damage. When cleaning the surface of the orifice plate, do not remove the interface heater. Frequent removal of the interface heater can result in damage to the interface heater. Surface cleaning of the interface heater is adequate for routine cleaning.

CAUTION: Potential System Damage. To avoid damaging the aperture, do not insert a wire or metal brush in the aperture on the curtain plate, orifice plate, or interface heater.

1. Dampen a lint-free wipe with LC-MS-grade water and then wipe the front of the orifice plate, including the interface heater.
2. Repeat step 1 using the cleaning solution.
3. Wait until the orifice plate is dry.
4. Inspect the orifice plate for solvent stains or lint, removing any residue with a clean, slightly damp, lint-free wipe.

Note: Persistent spotting or filming is an indicator of contaminated solvent.

Put the Mass Spectrometer Back in Service

1. Install the curtain plate.
2. Install the ion source on the mass spectrometer. Refer to the document: *Operator Guide* for the ion source.
Tighten the ion source by turning the source latches down in the locking position.
3. Active the devices. Refer to the document: *Software User Guide*.

Empty the Source Exhaust Drain Bottle



WARNING! Hot Surface Hazard. Let the Turbo V ion source cool for at least 30 minutes before starting any maintenance procedures. Some surfaces of the ion source and vacuum interface become hot during operation.



WARNING! Ionizing Radiation Hazard, Biohazard, or Toxic Chemical Hazard. Deposit hazardous materials in appropriately labeled waste containers and dispose of them according to local regulations.

Service and Maintenance Information



WARNING! Ionizing Radiation Hazard, Biohazard, or Toxic Chemical Hazard. Take care to vent exhaust gases to a dedicated laboratory fume hood or exhaust system and make sure that the ventilation tubing is secured with clamps. Make sure that the laboratory has appropriate air exchange for the work performed.

Note: Make sure that there are no kinks, sags, or twists in the source waste line.

Inspect the source exhaust drain bottle regularly, and empty it before it becomes full. Also inspect the bottle and the fitting for leaks, and tighten connections or replace components, if required. Follow the steps in this procedure to empty the bottle.

1. Remove the ion source. Refer to the document: *Turbo V Ion Source Operator Guide*.
2. Loosen the clamps connecting the hoses to the cap of the source exhaust drain bottle.

Figure 5-4 Source Exhaust Drain Bottle

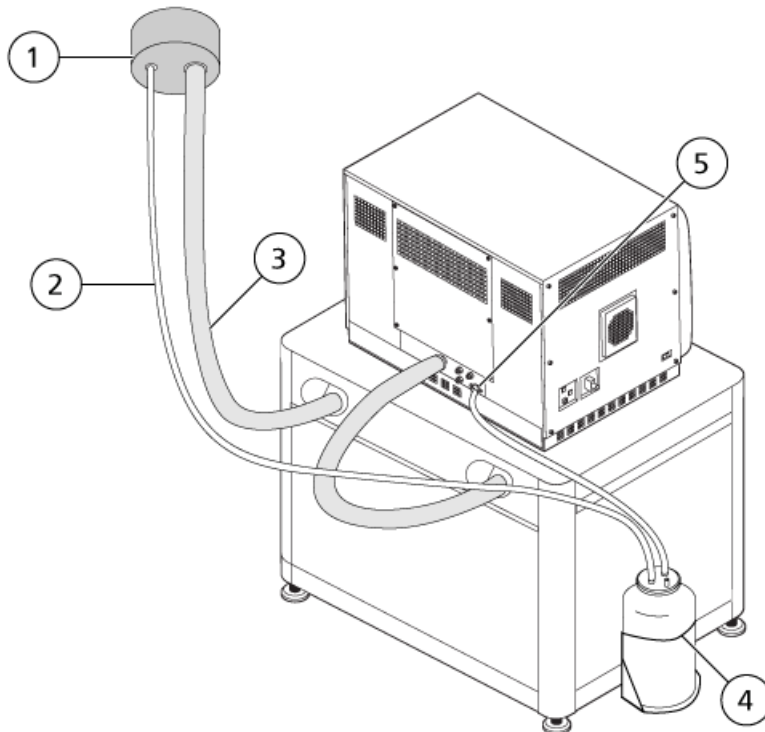

Item	Description
1	Connection to vent
2	Source exhaust drain tubing: 2.5 cm (1.0 inch) inner diameter (i.d.)
3	Roughing pump exhaust hose: 3.2 cm (1.25 inch) i.d.
4	Source exhaust drain bottle Make sure that the bottle is secured to prevent spillage.
5	Source exhaust connection to the mass spectrometer: 1.6 cm (0.625 inch) i.d.

Note: Source exhaust hose connections at the drain bottle, mass spectrometer, and the lab vent are secured with hose clamps.

3. If applicable, lift the drain bottle out of the holder.
4. Disconnect the hoses from the cap.
5. Remove the cap from the drain bottle.
6. Empty the drain bottle and then dispose of the waste according to laboratory procedures and local waste regulations.
7. Install the cap on the bottle and then put the bottle in the holder.
8. Attach the hoses to the cap and then secure them tightly with clamps.

Inspect the Roughing Pump Oil Level

- Inspect the sight glass on the roughing pump to verify that the oil is above the minimum level.

If the oil is below the minimum level, then contact the Qualified Maintenance Person (QMP) or SCIEX Field Service Employee (FSE).

Storage and Handling



WARNING! Environmental Hazard. Do not dispose of system components in municipal waste. Follow local regulations when disposing of components.

Service and Maintenance Information

If the mass spectrometer must be stored for a long time or prepared for shipping, then contact a SCIEX FSE for decommissioning information. To disconnect power from the mass spectrometer, remove the mains supply connector from the AC mains supply.

Note: The ion source and mass spectrometer must be transported and stored at a temperature between $-30\text{ }^{\circ}\text{C}$ to $+60\text{ }^{\circ}\text{C}$ ($-22\text{ }^{\circ}\text{F}$ to $140\text{ }^{\circ}\text{F}$) and relative humidity not exceeding 99%, non-condensing. Store the system at an altitude not exceeding 2,000 m (6,562 feet) above sea level.

Mass Spectrometer Troubleshooting

6

This section contains information for troubleshooting basic system issues. Certain activities can only be carried out by a SCIEX-trained Qualified Maintenance Person (QMP) in the laboratory. For advanced troubleshooting, contact a SCIEX Field Service Employee (FSE).

Table 6-1 System Issues

Symptom	Possible Cause	Corrective Action
The QJet ion guide is extremely dirty or frequently becomes dirty.	The flow rate of the gas for the Curtain Gas interface is too low.	Examine the setting for the gas for the Curtain Gas interface and increase it, if applicable.
A system fault has occurred because the vacuum pressure is too high.	<ol style="list-style-type: none"> 1. The roughing pump oil level is too low. 2. There is a leak. 3. The wrong orifice plate is installed. 	<ol style="list-style-type: none"> 1. Inspect the roughing pump oil level and then contact the local QMP or an FSE to add oil. Refer to the section: Inspect the Roughing Pump Oil Level. 2. Inspect and repair leaks. 3. Install the correct orifice plate.
A system fault has occurred because the QPS exciter module temperature is too high.	<ol style="list-style-type: none"> 1. The mass spectrometer air filter is blocked. 2. Ambient temperature is too high. 	<ol style="list-style-type: none"> 1. Contact the local QMP or FSE. 2. For the ambient temperature specifications, refer to the document: <i>Site Planning Guide</i> for the system.

Mass Spectrometer Troubleshooting

Table 6-1 System Issues (continued)

Symptom	Possible Cause	Corrective Action
The control software reports that the mass spectrometer is in Fault status because of the ion source.	<ol style="list-style-type: none">1. The probe is not installed.2. The probe is not connected securely.	<p>Confirm the fault in the Status panel of the device details page.</p> <ol style="list-style-type: none">1. Install the probe. Refer to the document: <i>Turbo V Ion Source Operator Guide</i>.2. Remove and then install the probe. Tighten the retaining ring securely. Refer to the document: <i>Turbo V Ion Source Operator Guide</i>.
The control software indicates that the APCI probe is in use, but the TurbolonSpray probe is installed.	The F3 fuse is blown.	Contact an FSE.
The spray is not uniform.	The electrode is blocked.	Clean or replace the electrode. Refer to the document: <i>Turbo V Ion Source Operator Guide</i> .
The interface heater is not ready.	The interface heater is faulty.	Contact the local QMP or FSE.
The mass spectrometer resolution is poor.	The mass spectrometer is not tuned.	Use the control software to optimize the mass spectrometer. Refer to the document: <i>Software User Guide</i> for the control software.

Table 6-1 System Issues (continued)

Symptom	Possible Cause	Corrective Action
The mass spectrometer performance has degraded.	<ol style="list-style-type: none"> 1. The ion source conditions are not optimized. 2. The sample was not prepared correctly or the sample has degraded. 3. The sample inlet fittings are leaking. 	<ol style="list-style-type: none"> 1. Optimize the ion source conditions. Refer to the document: <i>Turbo V Ion Source Operator Guide</i>. 2. Confirm that the sample was prepared correctly. 3. Verify that the fittings are the right size and type and make sure that they are tight. Do not overtighten the fittings. Replace the fittings if leaks continue. 4. Install and optimize an alternate ion source. 5. Contact an FSE if the issue persists.
Arcing or sparks occur.	The position of the corona discharge needle is incorrect.	If the TurbolonSpray probe is being used, then turn the corona discharge needle toward the curtain plate and away from the stream of heater gas. Refer to the document: <i>Turbo V Ion Source Operator Guide</i> .

Table 6-2 Sensitivity Issues

Possible Cause	Corrective Action
Sensitivity is Decreased	
The ion source parameters are not optimized.	Optimize the ion source parameters.
The mass spectrometer is not optimized.	Use the control software to optimize the mass spectrometer. Refer to the document: <i>Software User Guide</i> .
The curtain plate is dirty.	Clean the curtain plate. Refer to the section: Clean the Curtain Plate .

Mass Spectrometer Troubleshooting

Table 6-2 Sensitivity Issues (continued)

Possible Cause	Corrective Action
The orifice plate is dirty.	Refer to the section: Clean the Front of the Orifice Plate or contact the local QMP or FSE.
The QJet ion guide or IQ0 lens is dirty.	Clean the QJet ion guide and IQ0 lens. Contact the local QMP or FSE.
Q0 region is dirty.	Test for contamination of the Q0 region. Contact the local QMP or FSE.
The syringe or sample line is leaking.	Inspect the syringe or sample line for leaks and repair any leaks found. Make sure that all fittings are the correct type and size.
The sample has degraded or has a low concentration.	Verify the sample concentration. Use a fresh sample.
The probe is not installed properly.	Remove and install the probe.
The ion source is not installed properly or it is faulty.	Remove and install the ion source, making sure that the latches are properly secured. If this does not resolve the issue, then install and optimize an alternate ion source.
One or more of the O-rings on the vacuum interface is missing.	If the O-rings are on the ion source, then install them on the vacuum interface. If they are missing, then replace them.
There is an issue with the LC system or connections.	Troubleshoot the LC system.
The Declustering Potential (DP) is not optimized.	Optimize DP.
The electrode is dirty or blocked.	Replace the electrode. Refer to the document: <i>Turbo V Ion Source Operator Guide</i> .
There is No Signal or the Signal is Unstable	
The tubing is blocked.	Replace the sample tubing.

Table 6-3 Background Noise Issues

Possible Cause	Corrective Action
The temperature, the spray voltage or the flow rate for the ion source gas 2 is too high.	Optimize the ion source parameters. Refer to the document: <i>Turbo V Ion Source Operator Guide</i> .
The syringe or sample line is dirty.	Clean or replace the syringe or sample line.
The curtain plate is dirty.	Clean the curtain plate. Refer to the section: Clean the Curtain Plate .
The orifice plate is dirty.	Clean the front of the orifice plate. Refer to the section: Clean the Front of the Orifice Plate .
The QJet ion guide or IQ0 lens is dirty.	Do a full cleaning of the front end components of the mass spectrometer. Contact the local QMP or FSE.
The Q0 region is dirty.	Clean the Q0 region. Contact the QMP or FSE.
Mobile phase is contaminated.	Replace the mobile phase.
The ion source is contaminated.	Clean or replace the ion source components and then condition the ion source and front end: <ol style="list-style-type: none"> 1. Move the probe to the furthest position from the aperture, vertically and horizontally. 2. Infuse or inject 50:50 methanol:water with a pump flow rate of 1 mL/min. 3. In the control software, set the temperature to 650, ion source gas 1 to 60, and ion source gas 2 to 60. 4. Set the flow rate for the gas for the Curtain Gas interface to 45 or 50. 5. Run for a minimum of 2 hours or preferably overnight for best results.

For sales, technical assistance, or service, contact an FSE or visit the SCIEX website at sciex.com for contact information.

Calibration Ions and Solutions

A

CAUTION: Potential Wrong Result. Do not use expired solutions or solutions that have not been stored at the indicated storage temperature.

Note: Immediately after use, put a cap on the bottle and then store it at 2 °C to 8 °C. Refer to the information on the label.

Table A-1 Tuning Frequency

Calibration		Resolution Optimization
Scan Type	Frequency	Frequency
Q1 and Q3	3 months to 6 months	3 months to 6 months
LIT	3 months to 6 months	3 months to 6 months

Table A-2 Suggested Tuning Solutions

System	Q1 and Q3		LIT
	Positive	Negative	Positive and Negative
Triple quadrupole LC-MS/MS system	POS PPG, 2e-7 M	NEG PPG, 3e-5 M	N/A
Linear ion trap LC-MS/MS system	POS PPG, 2e-7 M	NEG PPG, 3e-5 M	ES Tuning Solution (1:100 dilution)

Table A-3 Q1 and Q3 PPG Ion Scans

Polarity	Masses					
Positive	59.05	175.13	500.38	616.46	906.67	N/A
Negative	45.00	411.26	585.39	933.64	N/A	N/A









Table A-4 LIT Scans











Polarity	Masses			
Positive	118.09	322.05	622.03	922.01
Negative	112.99	431.98	601.98	N/A

Glossary of Symbols











B

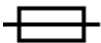





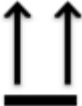

Note: Not all of the symbols in the following table are applicable to every instrument.

Symbol	Description
	Australian Regulatory Compliance Mark. Indicates that the product complies with Australian Communications Media Authority (ACMA) EMC Requirements.
	Alternating current
A	Amperes (current)
	Asphyxiation Hazard
	Authorized representative in the European community
	Biohazard
	CE Marking of Conformity
	cCSAus mark. Indicates electrical safety certification for Canada and USA.
	Catalog number
	Caution. Consult the instructions for information about a possible hazard. Note: In SCIEX documentation, this symbol identifies a personal injury hazard.







Symbol	Description
	<p>China RoHS Caution Label. The electronic information product contains certain toxic or hazardous substances. The center number is the Environmentally Friendly Use Period (EFUP) date, and indicates the number of calendar years the product can be in operation. Upon the expiration of the EFUP, the product must be immediately recycled. The circling arrows indicate the product is recyclable. The date code on the label or product indicates the date of manufacture.</p>
	<p>China RoHS logo. The device does not contain toxic and hazardous substances or elements above the maximum concentration values and it is an environmentally-friendly product that can be recycled and reused.</p>
	<p>Consult instructions for use.</p>
	<p>Crushing Hazard</p>
	<p>cTUVus mark for TUV Rheinland of North America</p>
	<p>Data Matrix symbol that can be scanned by a barcode reader to obtain a unique device identifier (UDI)</p>
	<p>Environmental Hazard</p>
	<p>Ethernet connection</p>
	<p>Explosion Hazard</p>
	<p>Eye Injury Hazard</p>

Glossary of Symbols

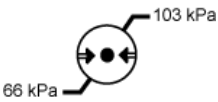
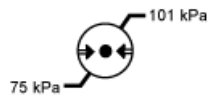
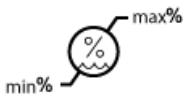
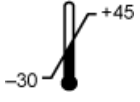
Symbol	Description
	Fire Hazard
	Flammable Chemical Hazard
	Fragile
	Fuse
Hz	Hertz
	International safety symbol "Caution, risk of electric shock" (ISO 3864), also known as High Voltage symbol If the main cover must be removed, then contact a SCIEX representative to prevent electric shock.
	Hot Surface Hazard
	In Vitro Diagnostic Device
	Ionizing Radiation Hazard
	Keep dry. Do not expose to rain. Relative humidity must not exceed 99%.
	Keep upright.
	Lacerate/Sever Hazard

Symbol	Description
	Laser Radiation Hazard
	Lifting Hazard
	Magnetic Hazard
	Manufacturer
	Moving Parts Hazard
	Pacemaker Hazard. No access to people with pacemakers.
	Pinching Hazard
	Pressurized Gas Hazard
	Protective Earth (ground)
	Puncture Hazard
	Reactive Chemical Hazard
	Serial number

Glossary of Symbols

Symbol	Description
	Toxic Chemical Hazard
	Transport and store the system within 66 kPa to 103 kPa.
	Transport and store the system within 75 kPa to 101 kPa.
	Transport and store the system within the specified minimum (min) and maximum (max) levels of relative humidity, noncondensing.
	Transport and store the system within $-30\text{ }^{\circ}\text{C}$ to $+45\text{ }^{\circ}\text{C}$.
	Transport and store the system within $-30\text{ }^{\circ}\text{C}$ to $+60\text{ }^{\circ}\text{C}$.
	USB 2.0 connection
	USB 3.0 connection
	Ultraviolet Radiation Hazard
	United Kingdom Conformity Assessment Mark
VA	Volt Ampere (power)
V	Volts (voltage)
	WEEE. Do not dispose of equipment as unsorted municipal waste. Environmental Hazard

Glossary of Symbols

Symbol	Description
W	Watts
	<i>yyyy-mm-dd</i> Date of manufacture

Glossary of Warnings

C

Note: If any of the labels used to identify a component become detached, contact a Field Service Employee (FSE).

Label	Translation (if applicable)
FOR RESEARCH USE ONLY. NOT FOR USE IN DIAGNOSTIC PROCEDURES.	FOR RESEARCH USE ONLY. NOT FOR USE IN DIAGNOSTIC PROCEDURES.
IMPACT INDICATOR SENSITIVE PRODUCT WARNING	IMPACT INDICATOR SENSITIVE PRODUCT WARNING <hr/> Note: If the indicator is tripped, then this container has been dropped or otherwise mishandled. Make a note on the Bill of Lading and then check for damage. Any claims for shock damage require a notation.
IMPORTANT! RECORD ANY VISIBLE CRATE DAMAGE INCLUDING TRIPPED "IMPACT INDICATOR" OR "TILT INDICATOR" ON THE WAYBILL BEFORE ACCEPTING SHIPMENT AND NOTIFY YOUR LOCAL AB SCIEX CUSTOMER SUPPORT ENGINEER IMMEDIATELY. DO NOT UNCRATE. CONTACT YOUR LOCAL CUSTOMER SUPPORT ENGINEER FOR UNCRATING AND INSTALLATION.	IMPORTANT! RECORD ANY VISIBLE CRATE DAMAGE INCLUDING TRIPPED "IMPACT INDICATOR" OR "TILT INDICATOR" ON THE WAYBILL BEFORE ACCEPTING SHIPMENT AND NOTIFY YOUR LOCAL AB SCIEX CUSTOMER SUPPORT ENGINEER IMMEDIATELY. DO NOT UNCRATE. CONTACT YOUR LOCAL CUSTOMER SUPPORT ENGINEER FOR UNCRATING AND INSTALLATION.
MINIMUM OF SIX PERSONS REQUIRED TO SAFELY LIFT THIS EQUIPMENT	MINIMUM OF SIX PERSONS REQUIRED TO SAFELY LIFT THIS EQUIPMENT

Label	Translation (if applicable)
TIP & TELL	<p>Tilt Indicator</p> <hr/> <p>Note: Indicates whether the container was tipped or mishandled. Write on the Bill of Lading and inspect for damage. Any claims for tipping require a notation.</p>
TiltWatch PLUS ShockWatch	<p>Tilt Indicator</p> <hr/> <p>Note: Indicates whether the container was tipped or mishandled. Write on the Bill of Lading and inspect for damage. Any claims for tipping require a notation.</p>
WARNING: DO NOT OPERATE WITHOUT FIRST ENSURING BOTTLE CAP IS SECURED.	<p>WARNING: DO NOT OPERATE WITHOUT FIRST ENSURING BOTTLE CAP IS SECURED.</p> <hr/> <p>Note: This warning is attached to the source exhaust waste bottle.</p>
WARNING: NO USER SERVICEABLE PARTS INSIDE. REFER SERVICING TO QUALIFIED PERSONNEL.	<p>WARNING: NO USER SERVICEABLE PARTS INSIDE. REFER SERVICING TO QUALIFIED PERSONNEL.</p> <hr/> <p>Note: Consult instructions for use.</p>

Contact Us

Customer Training

- In North America: NA.CustomerTraining@sciex.com
- In Europe: Europe.CustomerTraining@sciex.com
- Outside the EU and North America, visit sciex.com/education for contact information.

Online Learning Center

- [SCIEX Now Learning Hub](#)

SCIEX Support

SCIEX and its representatives maintain a staff of fully-trained service and technical specialists located throughout the world. They can answer questions about the system or any technical issues that might arise. For more information, visit the SCIEX website at sciex.com or contact us in one of the following ways:

- sciex.com/contact-us
- sciex.com/request-support

CyberSecurity

For the latest guidance on cybersecurity for SCIEX products, visit sciex.com/productsecurity.

Documentation

This version of the document supercedes all previous versions of this document.

To view this document electronically, Adobe Acrobat Reader is required. To download the latest version, go to <https://get.adobe.com/reader>.

To find software product documentation, refer to the release notes or software installation guide that comes with the software.

To find hardware product documentation, refer to the *Customer Reference* DVD that comes with the system or component.

The latest versions of the documentation are available on the SCIEX website, at sciex.com/customer-documents.

Note: To request a free, printed version of this document, contact sciex.com/contact-us.
